

TOTAL COMMITMENT IN SAFETY



1
VOLUME
2019

P.S.P.

MARKETING SDN. BHD.

P.S.P. Marketing Sdn. Bhd. is a registered Private Limited Company in Malaysia and is wholly owned subsidiary of INM Industries & Marketing Sdn Bhd.

PSP was formed on 2nd February 1994 to distribute and market a wide range of Personal Protective Equipment. We represent some of the most established agencies such as Ansell (Australia), Uvex (Germany), Moldex (USA), Honeywell (Canada), Showa (Japan) & etc.

Beside distributing full range of Personal Safety Products, we are also engaged in In-House Safety Training for all our customers. PSP has been committed to its core set of values: The customer, quality, innovation, teamwork and integrity, which serves as our operational foundation and are integrated into our overall business strategy. PSP provides the solutions that enables our customers to meet their demands.



CARLOS ARBOLES S.A

crisben

SC Johnson
PROFESSIONAL
A family company™

Honeywell



JUSTRITE®

Lakeland
INDUSTRIES INC
Be Safe. Be Sure. Wear Lakeland

Makrite®
Life Holds Unlimited Possibilities

Master
Lock

MOLDEX®
Ideas that wear well.

PROTECTA











SHOWA
Always Innovating. Never Imitating.

TAEKI 5™

uvex











BE SAFE

Contents

	House Safety Shoes	4 - 11
	House Eye Protection	12 - 13
	House Personal Protection	14
	House Respiratory Protection	15
	Makrite Respiratory Protection	16
	3M Respiratory Protection	17
	MOLDEX Respiratory & Hearing Protection	18
	Honeywell Hearing Protection	19
	Honeywell Gas Detector	20
	Method Emergency Showers & Eyewash	21
	SC Johnson Professional Heavy Duty Foaming Hand Cleanser	22
	Lakeland Protective Apparel	23
	Lakeland Arc Flash Protection	24
	Crisben Universal & Oil Absorbents	25
	JUSTRITE Safety Containment System	26
	Ansell General Purpose Gloves	27 - 30
	TAEKI5 General Purpose Gloves	30
	SHOWA Protective Gloves	31 - 33
	HANVO & HTR Protective Gloves	34
	PROMED First Aid Kit	35
	BEESAFE Fall Protection	36
	Master Lock - Lockout Tagout	37
	Traffic Management	38
	Safety Signages	39



Revolutionary Design Safety Shoes

-  Water Resistant Upper
-  Breathable Leather Uppers
-  Slip Resistant Sole
-  Anti Static
-  Oil and Fuel Resistant Sole
-  Composite Toecap
-  Aramid Midsole
-  Heel Energy Absorption
-  Comfortable Inner Liner
-  Light Weight





EN ISO 20345 2011

- Out Sole - Dual Density PU / PU
- Toe Cap - Steel
- Mid Sole - Steel
- Category - SBP SRA
- Lining - Mesh Nylon
- Insole - Premoulded
- Size Range - EU36-47



Madrid

EN ISO 20345 2011

- Out Sole - Dual Density PU / PU
- Toe Cap - Steel
- Mid Sole - Steel
- Category - SBP SRA
- Lining - Mesh Nylon
- Insole - Premoulded
- Size Range - EU36-47



Marseille

EN ISO 20345 2011

- Out Sole - Dual Density PU / PU
- Toe Cap - Steel
- Mid Sole - Steel
- Category - SBP SRA
- Lining - Mesh Nylon
- Insole - Premoulded
- Size Range - EU36-47



Bristol

EN ISO 20345 2011

- Out Sole - Dual Density PU / PU
- Toe Cap - Steel
- Mid Sole - Steel
- Category - SBP SRA
- Lining - Mesh Nylon
- Insole - Premoulded
- Size Range - EU36-47



Bonn



EN ISO 20345 2011

- Out Sole - Eva & Nitrile Rubber
- Toe Cap - Composite
- Mid Sole - Aramid
- Shoe Upper - Microfibre Leather
- Category - S3
- Lining - Mesh Nylon
- Insole - Premoulded
- Size Range - EU36-47



Milan

EN ISO 20345 2011

- Out Sole - Eva & Nitrile Rubber
- Toe Cap - Composite
- Mid Sole - Aramid
- Shoe Upper - Microfibre Leather
- Category - S3
- Lining - Mesh Nylon
- Insole - Premoulded
- Size Range - EU38-47



Munich

EN ISO 20345 2011

- Out Sole - Eva & Nitrile Rubber
- Toe Cap - Composite
- Mid Sole - Aramid
- Shoe Upper - Microfibre Leather
- Category - S3
- Lining - Mesh Nylon
- Insole - Premoulded
- Size Range - EU36-47



Leeds

EN ISO 20345 2011

- Out Sole - Eva & Nitrile Rubber
- Toe Cap - Composite
- Mid Sole - Aramid
- Shoe Upper - Microfibre Leather
- Category - S3
- Lining - Mesh Nylon
- Insole - Premoulded
- Size Range - EU39-47



Brussels



Safety Shoes

EN ISO 20345 2011

- Out Sole - Dual Density PU / PU (ESD)
- Toe Cap - Composite
- Mid Sole - Aramid
- Shoe Upper - Microfibre Leather
- Category - S3
- Lining - Mesh Nylon
- Insole - Premoulded
- Size Range - EU36-47



York

EN ISO 20345 2011

- Out Sole - Dual Density PU / PU (ESD)
- Toe Cap - Composite
- Mid Sole - Aramid
- Shoe Upper - Microfibre Leather
- Category - S3
- Lining - Mesh Nylon
- Insole - Premoulded
- Size Range - EU36-47



Berlin

EN ISO 20345 2011

- Out Sole - Dual Density PU / PU
- Toe Cap - Steel
- Mid Sole - Steel
- Shoe Upper - Microfibre Leather
- Category - S3
- Lining - Mesh Nylon
- Insole - Premoulded
- Size Range - EU40-44



Lancaster

EN ISO 20345 2011

- Out Sole - Dual Density PU / PU
- Toe Cap - Steel
- Mid Sole - Steel
- Shoe Upper - Microfibre Leather
- Category - S3
- Lining - Mesh Nylon
- Insole - Premoulded
- Size Range - EU39-47



Manchester



Bradford

EN ISO 20345 2011

- Out Sole - Eva & Nitrile Rubber
- Toe Cap - Composite
- Mid Sole - Aramid
- Shoe Upper - Microfibre Leather
- Category - SBP
- Lining - Mesh Nylon
- Insole - Premoulded
- Size Range - EU39-44, 46



Oxford

EN ISO 20345 2011

- Out Sole - Eva & Nitrile Rubber
- Toe Cap - Composite
- Mid Sole - Aramid
- Shoe Upper - Microfibre Leather
- Category - SBP
- Lining - Mesh Nylon
- Insole - Premoulded
- Size Range - EU38-44, 46



Stamford

EN ISO 20345 2011

- Out Sole - Eva & Nitrile Rubber
- Toe Cap - Composite
- Mid Sole - Aramid
- Shoe Upper - Microfibre Leather
- Category - SBP
- Lining - Mesh Nylon
- Insole - Premoulded
- Size Range - EU39-44, 46



Trafford

EN ISO 20345 2011

- Out Sole - Eva & Nitrile Rubber
- Toe Cap - Composite
- Mid Sole - Aramid
- Shoe Upper - Microfibre Leather
- Category - SBP
- Lining - Mesh Nylon
- Insole - Premoulded
- Size Range - EU39-44, 46





EN ISO 20345 2011

- Out Sole - Foam Rubber
- Toe Cap - Composite
- Mid Sole - Aramid
- Shoe Upper - Microfibre Leather
- Category - S3
- Lining - Mesh Nylon
- Insole - Premoulded
- Size Range - EU36-47



Amsterdam

EN ISO 20345 2011

- Out Sole - Foam Rubber
- Toe Cap - Composite
- Mid Sole - Aramid
- Shoe Upper - Microfibre Leather
- Category - S3
- Lining - Mesh Nylon
- Insole - Premoulded
- Size Range - EU36-47



Rotterdam

EN ISO 20345 2011

- Out Sole - Eva & Nitrile Rubber
- Toe Cap - Composite
- Mid Sole - Aramid
- Shoe Upper - Microfibre Leather
- Category - S3
- Lining - Mesh Nylon
- Insole - Premoulded
- Size Range - EU36-42



Sofia

EN ISO 20345 2011

- Out Sole - Eva & Nitrile Rubber
- Toe Cap - Composite
- Mid Sole - Aramid
- Shoe Upper - Microfibre Leather
- Category - SBP
- Lining - Mesh Nylon
- Insole - Premoulded
- Size Range - EU39-46



Florence



EN ISO 20345 2011

- Out Sole - Eva & Nitrile Rubber
- Toe Cap - Composite
- Mid Sole - Aramid
- Shoe Upper - Microfibre Leather
- Category - SBP
- Lining - Mesh Nylon
- Insole - Premoulded
- Size Range - EU39-44, 46, 47



Bolton

EN ISO 20345 2011

- Out Sole - Eva & Nitrile Rubber
- Toe Cap - Composite
- Mid Sole - Aramid
- Shoe Upper - Microfibre Leather
- Category - SBP
- Lining - Mesh Nylon
- Insole - Premoulded
- Size Range - EU39-44, 46, 47



Preston

EN ISO 20345 2011

- Out Sole - Eva & Nitrile Rubber
- Toe Cap - Composite
- Mid Sole - Aramid
- Shoe Upper - Microfibre Leather
- Category - SBP
- Lining - Mesh Nylon
- Insole - Premoulded
- Size Range - EU39-44, 46, 47



Norwich

EN ISO 20345 2011

- Out Sole - Eva & Nitrile Rubber
- Toe Cap - Composite
- Mid Sole - Aramid
- Shoe Upper - Microfibre Leather
- Category - SBP
- Lining - Mesh Nylon
- Insole - Premoulded
- Size Range - EU39-44, 46, 47



Ipswich



Safety Shoes

EN ISO 20345 2011

- Out Sole - Rubber Sole
- Toe Cap - Steel
- Mid Sole - Steel
- Shoe Upper - Microfibre Leather
- Category - S3
- Lining - Mesh Nylon
- Insole - Premoulded
- Size Range - EU38-47



London

EN ISO 20345 2011

- Out Sole - Rubber Sole
- Toe Cap - Steel
- Mid Sole - Steel
- Shoe Upper - Microfibre Leather
- Category - S3
- Lining - Mesh Nylon
- Insole - Premoulded
- Size Range - EU38-47



Lincoln



House Tornado 9175C

Safety Spectacle Adj. Black Frame A/F Clear (w/o strap)

- Single piece impact resistance polycarbonate lens
- UV, Scratch Resistance and Anti-fog lens
- Stylish wraparound design with curve lens for a snug secure fit
- Lens are available in Clear
- Light weight meets all aspect of ANSI Z87.1-2003
- Sidearm length is adjustable into 3 positions
- Sidearm inclination can be integrated and adjusted



House Raptor 9250

Overspec OTG Blue Clear A/F Lens

- Designed to fit Asian's facial feature
- Adjustable temple length-enables wearers to fit eyewear to their facial profile
- Features with ratchet ARV1 system
- Anti-fog lens
- EN 166-2001 and ANSI Z87.1-2003

House Thunder 9180C

Safety spectacle Adj. Black/Purple frame A/F Clear Lens

- The frame design which can be prescribed with prescription lenses
- Light weight meets all aspect of ANSI Z87.1-2003
- Side arm length is adjustable to fit



Typhoon 9310

- Wide vision goggle providing comfort and maximum protection
- Economical and comfortable goggle with anti fog
- Adjustable strap and fit over most prescription glass
- Wrap around high tech styling provides excellent panoramic vision
- EN 166-2001 and ANSI Z87.1-2003



Clear Lens



Mirage 9160

- Single piece impact resistance polycarbonate lens
- Soft flexible nose bridge ensure comfort fit and reduce slippage
- Lens UV Resistance and Anti-fog
- Stylish wraparound design with curve lens for a snug secure fit
- Lens available in Clear/Gray/Indoor-Outdoor
- Light weight meets all aspect of ANSI Z87.1-2003

Indoor &
Outdoor Lens



Gray Lens

Phantom 9165

- Single piece impact resistance polycarbonate lens
- Soft flexible nose bridge ensure comfort fit and reduce slippage
- Lens UV Resistance and Anti-fog
- Stylish wraparound design with curve lens for a snug secure fit
- Lens available in Clear
- Light weight meets all aspect of ANSI Z87.1-2003



Clear Lens

Hawk 9170

- Single piece impact resistance polycarbonate lens
- Soft flexible nose bridge ensure comfort fit and reduce slippage
- Lens UV Resistance and Anti-fog
- Stylish wraparound design with curve lens for a snug secure fit
- Light weight meets all aspect of ANSI Z87.1-2003
- Adjustable Nose Bridge
- Metal Free Temple





STEALTH



House PVC Wellington Boots CE

Its characters are anti-acid, anti alkaline, anti oil, anti slip, erode resistance, temp resistance, puncture assistance, abrasion assistance. It can be applied in oil field, metal work, chemicals, machinery, fire control industry. It meets CE EN ISO20345:2004 standard.

Premium House Back-Support Belt

House Back-Support Belt is lumbar support system which has been carefully designed to assist maintaining proper balance, correcting curves of the spine and encouraging correct posture and relieving fatigue caused from:

- long-distance/time driving or sitting
- Exercises
- Incorrect posture or body movement
- Defective upper or lower back due from aging injury, etc. constructed back support that allows you to perform complete range of motion, yet comfortable to wear.

SIZE: S, M, L, XL, 2XL, 3XL



SH2550

N95 Particulate Respirator



SH2550V

N95 Valved Particulate Respirator



SH2550CV

N95 Valved OV Particulate Respirator



SH2550A

N95 OV/AG Particulate Respirator

- Patent-pending adjustable headstrap buckle for personal adjustment.
- No metal used. Avoid the contact between skin and metal. Suitable for those environments where metal is not allowed.
- Cool latex-free cloth headstrap for comfortable wearing.
- Continuous loop headstrap design allows the mask to hang around the neck when not in use.
- Polypropylene (P.P.) inner layer provides the most intimate touch to your face.
- Pre-shaped nose cushion and soft closed-cell nose foam ensures custom shape and increase the worker's comfort and acceptance.
- Embossed fringe seal avoids fluffy open layer around the edges.
- Contour design ensures the compatibility of glasses/goggles and reduces fogging.



MAK 368+

MAK 520+

MAK 699+



N95 Particulate Respirators



9600-N95

These masks are intended to be used for protection against solid, such as those from minerals, coal, iron ore, flour and certain other substances. They are extremely durable, have a soft and comfortable inner surface, an adjustable nose piece and secure head straps to provide proper fit.



9600-N95OV

These masks are intended to be used for protection against solid, such as those from minerals, coal, iron ore, flour and certain other substances. They are extremely durable, have a soft and comfortable inner surface, an adjustable nosepiece and secure headstraps to provide proper fit. but also when there are nuisance odors in the environment. These respirators are loaded with a high quality activated carbon material to provide long lasting relief and reduce worker fatigue.



3000 Series Single Respirator Model 3200



3000 Series Single Respirator Model 3100



3311K-55 Organic Vapor Cartridge



Filter Holder 3700



3744 Particulate Filter

3000 Series Single Respirator

JKKP MR46/98

- Made of Thermoplastic Elastomer
- Two customized Asian size face pieces for more secure fit & seal
- Textured face piece to prevent slipping & maintain consistent seal at all times
- Compact design increases vision & safety
- Lightweight body & cradle head harness increase comfort
- Snap fit cartridges for easy assembly
- Drop-down strap for wearer convenience & acceptance
- Use with 3M 3000 series Cartridges / Filters

3000 Series Cartridges / Filters

Product Code	Description
Respirator	
3100	Small / Medium size Respirator
3200	Medium / Large size Respirator
Cartridges / Filters	
3311K-55	Organic Vapor Cartridge with Dust / Mist Filter, 55cc
3700	Filter Holder (to hold 3744 particulate filter)
3744	Particulate Filter



6000 Series Half Mask Respirator

JKKP MR137/01

- Durable & Lightweight Thermoplastic Elastomer
- Low-maintenance design for maximum comfort
- Use with 3M 6000 series cartridges and or 2000 series filters. Combination with N95 filters / P100 filters are available



6000 Series Full Face Respirator

JKKP MR43/98

- Offers low-cost, low-maintenance facepiece with wide vision to enhance safety
- Silicone face seal with 4 point Thermoplastic Elastomer harness
- Use with 3M 6000 series cartridges and or 2000 series filters. Combination with N95 filters / P100 filters are available

6000 Series Cartridges & Filters

Product Code	Description
Respirator	
6100	Small size Half Mask Respirator
6200	Medium size Half Mask Respirator
6300	Large size Half Mask Respirator
6700	Small size Full Face Respirator
6800	Medium size Full Face Respirator
6900	Large size Full Face Respirator
Cartridges	
6001	Organic Vapor Cartridge
6002	Acid Gas Cartridge
6003	Organic Vapor / Acid Gas Cartridge
6004	Ammonia / Methylamine Cartridge
6005	Formaldehyde / Organic Vapor Cartridge
6006	Multi Gas & Vapor Cartridge
6009	Mercury Vapor Cartridge

Product Code	Description
Filters	
2071	P95 Filter
2076HF	P95 Filter for Hydrogen Fluoride & Nuisance Level Acid Gas relief <i>Remark: For HF use full face respirator for protection up to 10x OEL</i>
2078	P95 Filter for Nuisance Level Organic Vapor & Acid Gas relief <i>Remark: For Ozone, use 6000 series respirator up to 10x OEL</i>
2091	P100 Filter
2096	P100 Filter for Nuisance Level Acid Gas relief
2097	P100 Filter for Nuisance Level Organic Vapor relief
5N11	N95 Filter
5P71	N95 Filter
7093	P100 Filter
7093C	Cartridge / Filter Hydrogen Fluoride, P100 with Nuisance level Organic Vapor / Acid Gas relief
Retainer / Adapter	
501	Filter retainer (for use with 5N11 / 5P71)
502	Filter retainer (for use with 2000 series filters / 7093 filter)



7000/9000 Series Reusable Respirators
Compliance just got a whole lot easier

Moldex designed the 7000 half mask and 9000 full face series to be the most user friendly respirators on the market. The stream-lines 7000/9000 feature fewer parts, minimal maintenance, and a wider field of vision. They are both ultra-lightweight, durable, and economical, so maximum comfort with extended use is built-in.

The 7000/9000 series add up to simple, comfortable, and economical respiratory protection that's just plain EASY TO WEAR.



7000/9000 Series Gas/Vapor Cartridges

- 7300 Organic Vapors/Acid Gases
- 7600 Multi-Gas/Vapor Smart Cartridge



7000/9000 Series Particulate Filters

- Use 8910 N95 or 8970 R95 Pre-filter with the 7020 Pre-filter Retainer with any Gas/Vapor Cartridge.
- Use the 7940 P100 Filter Disk or 7960 P100 Filter Disk plus Nuisance OV as a stand alone filter or use the 7940 with the 7920 Piggyback Adapter with any Gas/Vapor Cartridge.



8910 N95 Filter

7020 Pre-Filter Retainer

7940 P100 Filter Disk

7920 Piggyback Adapter

Pura-Fit Foam Earplugs (NRR 33dB)

- Soft PVC -Free foam for all day comfort.
- Tapered shape for easy insertion.
- Longer length easy fitting and removal.
- Exclusive bright green color for easy compliance checks.
- An industry favorite.



Jet™ Earplugs (NRR 27dB)

- Extra-soft material and triple flange design seal gently and snugly without pressure
- High visibility green swirls plus bright green cord make compliance checks quick and easy
- Optional cloth cord attachers easily for a variety of working conditions and locks securely to plug
- Plugs can be washed and reused



PlugsStations (NRR 33dB)

- Increases compliance. Puts plug in easily accessible areas so workers use them.
- Lowers usage – workers take just one pair.
- Sealed PlugStation ensure plugs stay sanitary.
- Affordable enough to mount in any location that requires hearing protection.
- Eliminates individual packaging, less mess and maintenance.
- Mounting bracket, template and hardware included with every PlugStation.
- Dispenser is completely recyclable.
- Can be used alone or with The One-Stop PlugShop.



6644

6845



Leightning® Series™

Bright green earcup provide high visibility and safety on the job. Exclusive reflective headband highly visible under light for increased visibility and safety especially in low lighting. Ideal to wear at night, in low lighting and under inclement weather condition.

PRODUCT CODE:
LEIGHTNING® L3HV
NRR 30dB



Thunder™

Robust steel wire construction withstands demanding use, especially in tough environments. Padded foam headband delivers long wearing comfort with minimal pressure on the head.

Applications
Textiles, Lumber Products, Printing, Airlines, Shooting/ Gun Ranges, Machinery

PRODUCT CODE :
THUNDER™
T1 - NRR 26dB

Thunder™

Robust steel wire construction withstands demanding use, especially in tough environments. Padded foam headband delivers long wearing comfort with minimal pressure on the head.

Applications
Textiles, Lumber Products, Printing, Airlines, Printing Industries Shooting/ Gun Ranges, Machinery

PRODUCT CODE:
THUNDER™ T1H NRR 23dB



SmartFit®

Advanced material uses body heat to adapt to the individual shape of each wearer's ear canal. Delivers superior comfort and a truly individual fit. Simplifies inventory, control-a single product fits almost every wearer. HearPack® storage case; unique detachable cord system. Process industry style available with attached cotton cord and paper bag (SMF-30W-P)

Applications
Airline, Printing and Machinery

PRODUCT CODE:
SMF 30
NRR 25dB



Max®

The world's most-used polyurethane earplug. Bell shape delivers maximum in-ear comfort. Improved design easier to insert, reduces tendency to back out of ear. Smooth, soilresistant skin prevents dirt build-up.

Applications
Airline, Printing and Machinery

PRODUCT CODE:
MAX-30 (corded)
MAX-1 (uncorded)
NRR 33dB

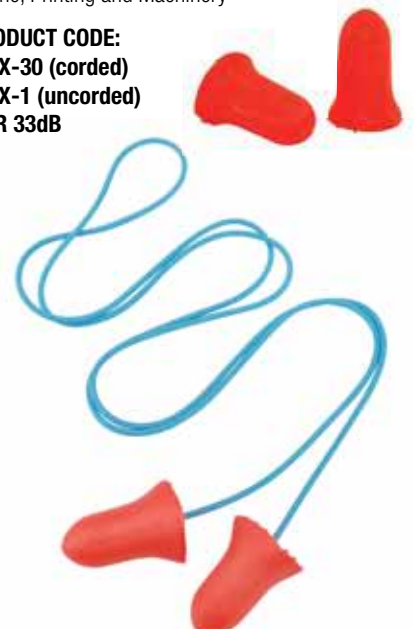



BW Clip4 Multi-Gas Detector

Easy to Wear

- Durable, ergonomic and wearable-doesn't weigh you down
- Compact profile-even working in tight spaces, you won't know you are wearing it

Easy to Use

- Simple one-button operation
- User-friendly tamper-proof operation with just one button
- Intuitive LC icons
- Real-time gas concentrations shown on LCD

Easy Compliance

- Flashing red non-compliance indicators warn workers that the detector has not been bump tested according to schedule
- Daily full function self-test of sensors, battery status, circuit integrity and audible/visual alarms

Easy to Manage

- Compatible with IntelliDoX docking system and instrument management system

Easy to Rely On

- Built-in concussion proof boot
- Tested to last in extreme environments



GasAlert Extreme Single-Gas Detector

Designed for most adverse conditions, the GasAlert Extreme single gas detector offers a wide range of user selectable options, a replaceable battery & can monitor a variety of toxic hazards.

- Small size & lightweight
- Internal vibrating alarm
- Rugged, IP66/67 highly water-resistant design
- Continuous LCD shows real-time gas concentration with backlight in low-light



GasAlert MicroClip Multi-Gas Detector

- Rugged, compact & lightweight
- Standard datalogger (16 hours) & event logger (10 events)
- Durable, stainless steel alligator clip
- Integral concussion-proof boot for the most rugged environments
- Provides 95dB alarm tone & bright wide-angled alarm bar
- Equipped with internal vibrating alarm for high noise area
- Simple one button automatic calibration procedure
- Four alarm levels
- Powered by a lithium polymer battery



GasAlertMax XT II Multi-Gas Detector

GasAlertMax XT II is the smart, simple, economical way to compliance. Workers feel safe and incidents are minimized so everyone will be able to do more. That means savings realized from business continuity and productivity.

Simple operation, with SmartSample pump.

GasAlertMax XT II reliably monitors up to four hazards and combines straight forward one-button operation with our robust, motorized pump for intelligent, remote sampling, ideal for confined spaces. The GasAlertMax XT II is fully compatible with MicroDock II test and calibration system.



Honeywell BW™ Ultra Multi-Gas Detector

Extra Detection. Ultra Protection.

- Large, easy-to-view screen.
- Enhanced situational awareness for the hole watch.
- The new 1-Series sensor for enhanced reliability.
- Honeywell TouchConnect™ Technology for quick instrument management.
- Remote monitoring for an additional layer of protection.



Emergency Showers & Eyewash



Floor Mounted Eyewash With Stainless Steel Bowl

These units work very well in any environment. It can be mounted onto a floor and operated either by hand or by foot. **METHOD**® eyewash sprayheads use soft-flow aerators and automatic pressure compensating valve.

PRODUCT CODE:
EY 5060SS, EY 5070SS,
GIY 5060SS, GIY 5070SS



Floor Mounted Eyewash With ABS Plastic Bowl

This stand alone eyewash is mounted onto the floor and can operated either by hand or foot. **METHOD**® eyewash sprayheads use so-flow aerators and automatic pressure compensating valve.

PRODUCT CODE:
EY 5060AB, EY 5070AB,
GIY 5060AB, GIY 5070AB



Floor Mounted Combination Unit Of Drench Shower and Eyewash With Stainless Steel Bowis

Our combination unit of drench shower and eyewash is popular in workplace where fire and chemical spillages may occur. All control valves are the instant action, stay opened type of ball valve. The unit also comes with a foot pedal.

PRODUCT CODE:
ECB 10020SS, GIC 10020SS



Floor Mounted Combination Unit Of Drench Shower and Eyewash With ABS Bowls C/W Foot Pedal

The most popular combination unit of drench shower and eyewash for any industries, this unit is effective and highly recommended in all accident prone areas.

PRODUCT CODE:
ECB 10022AB,
GIC 10022AB



Vertically Mounted Drench Shower With ABS Plastic Bowl

This simple to operate overhead drench shower may just be what you are looking for. A durable and affordable choice, it is a must have in hazardous work surroundings.

PRODUCT CODE:
EQ 9910V



Wall Mounted Eyewash With Stainless Steel Bowl

Where space may be of constraint, **METHOD**® wall-mounted eyewash fits easily into your workplace. Eyewash works quickly with a simple push of its highly visible handle. **METHOD**® eyewash sprayheads use so-flow aerators and automatic pressure compensating valve.

PRODUCT CODE:
EY 5050



CLEANSE HEAVY



Deb® Gritty FOAM

A New generation Deb FOAM heavy duty hand cleanser

- Preferred by users, gentle on the skin, better for the environment and faster to use than conventional heavy duty hand cleansers.
- Gritty FOAM™ combines heavy duty hand cleanser ingredients and non-abrasive natural scrubbing agents.
- Dispensed as a powerful foam cleanser to remove many types of industrial contaminants.
- For use with GrittyFOAM™ dispenser.

Art No.	Size	Qty
GPF3L	3.25L Cartridge	4



Swarfega® Orange

- Uses a blend of non-ionic surfactants to remove oil, grease and general soiling quickly
- Contains natural cornmeal scrubbers which gives deep down clean and gently lift ingrained soiling without damaging the skin

Art No.	Size	Qty
8098	4L Pump Top Bottle	4



Deb® Ultra WASH

Specialist powerful hand cleanser with dibasic esters and corneal scrub to remove paints, inks, resins and adhesives and most other print & paintshop contaminants.

Art No.	Size	Qty
ULT4LTR	4L Cartridge	4



Deb® Suprega Plus

- Yellow flowing lotion has a light citrus odour making it pleasant to use
- Gently care for the hands whilst the Lanolin derivatives prevent skin dryness, chapping and cracking
- Humectant helps protect dryness
- Contains natural cornmeal scrubbers which gives a deep down clean and gently lift ingrained soiling without damaging the skin

Art No.	Size	Qty
5000	4L Cartridge	4



CLEANSE SHOWER



Estesol® Hair & Body

A universal, pleasantly fragranced hair & body shower gel

- Pleasantly fragranced unisex shower gel to remove general workplace dirt and grime
- Contains glycerin to help prevent skin dryness and leaves skin feeling soft and supple
- Quick and easy rinsing to leave no soapy residues

Art No.	Size	Qty
HAB1L	1L Cartridge	6
SHW1LDS	1L Dispenser	15



CLEANSE WASHROOM



Deb® Azure FOAM WASH

Pleasantly fragranced mild foam soap.

Art No.	Size	Qty
AZU1L	1L Cartridge	6
AZU120TF	1.2L TF Cartridge	3



CLASSIC FOAMS



Refresh™ Clear FOAM

Perfume-Free & Dye-Free Gentle Foam Hand Wash

- Perfume-free and dye-free formulation reduces risk of allergic reaction and skin irritation.
- Non tainting to food.
- Contains skin conditioners to improve skin hydration and prevent drying.

Art No.	Size	Qty
CLR1L	1L Cartridge	6
WRM1LDS	1L Dispenser	15



PROTECT



Deb® Universal PROTECT

Perfume-free, non-greasy pre-work cream to help protect the skin against contact with water and non-water based contaminants.

Art No.	Size	Qty
UPW150ML	150ml Tube	12
UPW1L	1L Cartridge	6



SANITISE



Deb® Instant FOAM

Highly effective, perfume & dye-free alcohol-based FOAM hand sanitiser. Kills 99.999% of many common germs in just 30 seconds. No water rinsing required. Conforms to EN1500, prEN12054, EN1275 and EN1040.

Art No.	Size	Qty
IFS50ML	47ml Pump Bottle	12
IFS250ML	250ml Pump Bottle	6
IFS400ML	400ml Pump Bottle	6
IFS1L	1L Pump Bottle	6
IFS1TF	1L TF Pump Bottle	3



ANTIBACTERIAL CLEANSERS



OxyBAC® FOAM Wash

Antibacterial rich-cream foam hand wash with Accelerated Hydrogen Peroxide®

- Perfume-free and preservative-free foam hand wash.
- Contains Accelerated Hydrogen Peroxide® a patented synergistic blend of commonly used ingredients that when combined with a low level of hydrogen peroxide (H₂O₂) is extremely effective at killing bacteria.
- Does not induce antibacterial resistance and hydrogen peroxide breaks down into oxygen and water with no environmental contamination.
- Specifically formulated for use in food handling environments where high levels of hand hygiene are required; independently tested to prove non-tainting to food.
- Hypoallergenic formula is safer for skin and safer for the environment compared with all other antibacterial soaps.

Art No.	Size	Qty
OXY1L	1L Cartridge	6
OXY12LTF	1.2L for TF White	3
ANT1LDS	1L Dispenser	15
TF2WHI	1.2L TF Dispenser	8

DEGREASER



Swarfega® Marinol

Bilge, tank and deck wash cleaner to remove grease, oil, fats and algae. Dilute with fresh or sea water. Bio-degradable and non-flammable.

Art No.	Size	Qty
0925	25L	1



Protective Apparel



ESGP528



SAFEGard GP

Serged Seam

Type 5, Type 6 Coverall. 3 tough layer; 2 outer layers is spun bounded filaments and inner layer is polypropylene microfibers.



CT1S428



ChemMax 1

Heat Sealed Seam

Type 4, Type 4 Coverall. High density polyethylene film barrier laminated to spunbond polypropylene substrate.



SMMS428E



SAFEGard 76

Sewm & Bound Seam

Type 5, Type 6 Coverall. 4 layers 55gsm polypropylene SMMS material offering improved particle barrier over 3 layers SMS.



CT2S428



ChemMax 2

Heat Sealed Seam

Type 4, Type 4 Coverall. The fabric features is Dow Saranex 23P barrier film bonded to a flexible bi-component spunbonded substrate provides excellent chemical protection.



AMN428E



MicroMaX NS

Serged Seam

Type 5, Type 6 Coverall. The garment made of high quality microporous film laminate. Spunbound polypropylene film. Fabric tested or biological penetration using US test ASTM F1671-97a.



CT3S428



ChemMax 3

Heat Sealed Seam

Type 4, Type 4 Coverall. Durable and lightweight, ChemMax 3 provides a barrier against a broad spectrum of toxic industrial chemicals, chemical warfare agents and other harmful contaminants. The multi-layer film is applied to a heavy polypropylene nonwoven for increased strength and durability. The barrier film is significantly softer than other products on the market, resulting in a quiet, more comfortable garment.



INT640



Interceptor Fully Encapsulated Front Entry Suit

Heat Sealed Seam Plus

Expanded back, attached sock boots with boot flaps. 122cm zipper (48"), double storm flap with hook and loop. 2 layers faceshield (10mil Teflon / 40mil PVC). Neoprene and North Silvershield™ glove system 2 exhaust valves.





HRC2 ATPV: 8.9 Cal/cm²

Styles		Product Code
Arc Flash Protective Shirt	1	AR8-S-DH
Arc Flash Protective Jacket	2	AR8-J-DH
Arc Flash Protective Pants	3	AR8-P-DH
Arc Flash Protective Robe	4	AR8-R-DH
Arc Flash Protective Gloves	7	AR8-G-DH
Arc Flash Protective Leg Covers	8	AR8-C-DH



HRC3 ATPV: 26 Cal/cm²

Styles		Product Code
Arc Flash Protective Suit		
Arc Flash Protective Hood / Long Coat / Bib	5 6 7 9	AR26
Arc Flash Protective Hood	9	AR26DH
Arc Flash Protective Robe	4	AR26-R-DH
Arc Flash Protective Long Coat	5	AR26SC
Arc Flash Protective Bib Pants	6	AR26B0
Arc Flash Protective Gloves	7	AR26-G-DH
Arc Flash Protective Leg Covers	8	AR26-C-DH



HRC4 ATPV: 48 Cal/cm²

Styles		Product Code
Arc Flash Protective Suit		
Arc Flash Protective Hood / Long Coat / Bib	5 6 7 9	AR48
Arc Flash Protective Hood	9	AR48DH
Arc Flash Protective Robe	4	AR48-R-DH
Arc Flash Protective Long Coat	5	AR48SC
Arc Flash Protective Bib Pants	6	AR48B0
Arc Flash Protective Gloves	7	AR48-G-DH
Arc Flash Protective Leg Covers	8	AR48-C-DH



Features Of DH Arc Flash Resistant Garment :

- Lakeland DH Arc Flash Resistant Garment is designed to provide a solution that bridges a vast number of industries and adheres to the most important performance standards, NFPA 70E;
- DH Arc Flash Resistant Garment has several APTV selections from HRC2 to HRC4;
- Lakeland DH Arc Flash Resistant Garment is designed with inherent FR properties; protection is built into the fiber. Normal laundry conditions will not adversely affect the performance of the garment.
- Under normal wear condition, Lakeland DH Arc Flash Resistant Garment can provide years of dependable and reliable service.
- Lakeland DH Arc Flash Resistant Garment is designed to provide comfort with performance and a high level of aesthetics. Natural feel is a result of a high percentage in the blend of Tencel, a hydrophilic fiber that enhances comfort.
- Economic, cost-effective.



Universal & Oil Absorbents

crisben



Booms H/D OBE200



Booms OBC420



Socks USC12076



Socks OSC12076



Pads OPC100, 200



Pads UPCD



Pillow UPIL & OPIL



**Wheel Bin Universal
& Oil Spill Kit**



Cabinet Universal / Oil Spill Kit



Universal / Oil Trolley



Vehicle Spill Kit

P/No.	Description	Size	Packing
Universal Absorbents			
UPIL 2025	Universal Chemical Pillows Disposable	20cm x 25cm	12pcs / bale
UPCD 100	Universal Chemical Pads (Grey) Dimpled	40cm x 50cm	100pcs / bale
UPCD 200	Universal Chemical Pads (Grey) Dimpled	40cm x 50cm	200pcs / bale
USC 12076	Universal Chemical Socks (Grey)	7.6cm x 1.2m	12pcs / bale
Oil Absorbents			
OPIL 4050	Oil Pillows Disposable	40cm x 50cm	10pcs / bale
OPIL 2025	Oil Pillows Disposable	20cm x 25cm	12pcs / bale
P 4050	Reusable Oil Absorbent Pillows	48cm x 48cm	6pcs / bale
OPC 200	Oil Pads (White)	40cm x 50cm	200pcs / bale
OPC 100	Oil Pads (White)	40cm x 50cm	100pcs / bale
OSC 12076	Oil Socks (White)	7.6cm x 1.2m	12pcs / bale
Spill Kits			
Transporter Spill Kit 120 / 240	Wheeled Bin Universal / Oil Spill Kit		
Cabinet Spill Kit	Cabinet Universal / Oil Spill Kit		
Trolley Spill Kit	Trolley Universal / Oil Spill Kit		
Vehicle Spill Kit	Bag Universal / Oil Spill Kit		



Safety & Storage Cabinets

For Flammables



8945201

8930001

For Combustibles



8930111

For Hazardous Material



8645261

8630281

8690261

For Corrosives



8913021 on top of 8930021



24160



24015

Safety Cans & Containers



7150100Z

7125100Z

7120100Z

7110100Z

Type I Safety Cans



14180Z

14085Z

Type I Poly Cans



8945201

7225130Z

7220120Z

8945201

Type II Accuflow Safety Cans



9300

Oily Waste Cans



12754

14265

Liquid Disposal Safety Cans



10008

10108

10208

Safety Plunger Cans

Safety Control & Environmental



28623

28635

EcoPolyBlend Spill Control Pallets



Open-view Sump

28665

EcoPolyBlend Spill Containment Caddy



General Purpose Gloves

Ansell



Edge Glove

Medium duty cut resistant industrial glove

- Good dexterity and flexibility
- High cut protection and abrasion level
- Good grip in dry environment
- Palm dipping provide good protection against oil compared to a knitted or cut & sew glove

Part No. : 48-705



Edge Industrial Work Glove

Heavy duty cut resistant industrial glove

- The nitrile foam coating delivers very good performance in terms of abrasion resistance & grip
- Choices for medium to heavy duty applications that require abrasion, grip and cut protection

Part No. : 48-706



Edge Industrial Work Glove

Good level of abrasion and tear resistance

- Seamless structure ; ensures comfort and encourages safety and glove usage
- Delivers good grip in dry to slightly oily environments

Part No. : 48-125 (White), 48-126 (Black)



Edge Industrial Work Glove

Medium duty general purpose industrial glove

- Good dexterity and flexibility
- Good level of abrasion resistance compared to other types of latex coated gloves
- Sure grip in dry and wet environments

Part No. : 48-305



Edge Glove

- Good level of abrasion
- Nitrile fully coating deliver long lasting performance
- Oil and liquid repellent

Part No. : 48-205



Edge Latex

- Thin, elastic formulation for dexterity
- Comfortable fit and easy to slip on
- Fully textured to improve grip

Part No. : 82-144



TouchNTuff

- Chemical resistance & provide three times the puncture
- Glove offers easy donning and strong grip in wet or dry conditions
- Delivers good grip in dry to slightly oily environments

Part No. : 92-600 (TNT Green), 4.7MIL

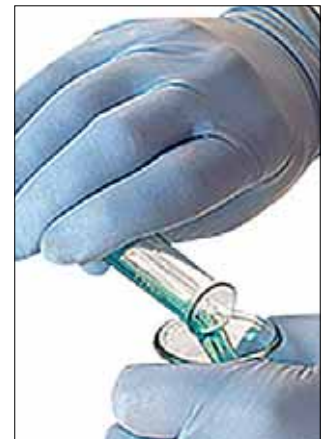

Microflex

Nitrile Blue Gloves

- Unparalleled comfort & sensitivity
- Reduced muscle effort
- Reliable durability
- Leading protection
- Protection type 1 allergies

Part No. : 93-733 (4MIL)



Edge @ Microflex Glove

- For heavy-duty extraction & maintenance work where cut & pinch hazards are present
- Bright yellow ensures that hands are visible at all times

Part No. : 48-128



Edge Impact Glove

- For heavy-duty extraction & maintenance work where cut & pinch hazards are present
- Bright yellow ensures that hands are visible at all times

Part No. : 48-500



Edge Disposable Nitrile Gloves

- Thinner nitrile formulation that increases comfort & improves flexibility
- Offer textured fingertips to provide an improved grip for a variety of applications

Part No. : 82-133 (2.5MIL)



Crusader Flex

- Nitrile coated with non-woven felt insulated resisting heat up to 200°C
- Lasts four times longer than 24-ounce cotton hot mill glove
- Sweat absorbent felt liner for added comfort

Part No. : 42-476



Solvex Nitrile Glove

- Superior to Neoprene & Latex in most solvents
- Component materials comply with HACCP standard, FDA approved
- New Solvex II Nitrile has raised diamond pattern for better grip

Part No. : 37-176 (13"), 37-185 (18")

JKKP HP 04/01
EN420, EN388, EN374



Scorpio Neoprene Fully Coated Glove

- Protects against a wide range of oils, acids, caustics, alcohols & many solvents
- Permits intermittent handling in hot liquids upto 180°C & handling in cold temperatures down to -25°C

Part No. : 09-924 (14"), 09-928 (18"), 09-430 (31")

JKKP HP 04/01
EN420, EN388, EN374



Microflex

- Thinnest chemical resistant synthetic composite disposable glove
- Three layer design for superior protection against harsh chemicals including acids, solvents and bases
- Extra soft material and ergonomic design for outstanding fit, feel and flexibility for longer wear time

Part No. : 93-260



TouchNTuff

- Chemical resistance & provide three times the puncture
- Application : Lab analysis/ technical work, manufacturing, maintenance & clean up

Part No. : 92-605 (12")



General Purpose Gloves

Ansell



Canners Blue

- Unsupported chemical resistant natural rubber glove
- Excellent dexterity, tensile strength and elasticity
 - Good resistance against mechanical and chemical hazards
 - Diamond embossed for excellent grip wet & dry surfaces

Part No. : 14-896



Hyflex Foam

- Foam nitrile coating helps reduce hand fatigue & provides maximum comfort and dexterity
- Resistant to snags and abrasion
- Provides excellent grip in light oil applications

Part No. : 11-800



Neoprene Glove

- Good for handling acids, oil, caustics & alcohols
- Case is hardened to enhanced chemical & abrasion resistance

Part No. : 29-865 (13")

JKKP HP 02/01
EN420, EN388, EN374



Alphatec Chemical Resistance Glove

- Ansell grip technology
- Heavy duty gloves
- Nitrile coating offers superior snag, puncture & abrasion protection for long term wear

Part No. : 58-535 (14")



Alphatec® (ex Bi-Colour™)

- Latex/neoprene blend for reliable protection against a very wide range of chemicals
- Double dipped for double protection
- Heavyweight resistance to salts and detergents

Part No. : 87-900



Barrier Glove

- Offer the broadest range of chemical resistance
- Ideal to wear as a liner glove & when handling hazardous chemicals i.e. environmental cleaning & emergency response

Part No. : 02-100

JKKP HP 01/01
EN420, EN388, EN374



Scorpio Neoprene-Coated

- Neoprene coated with rough finish to make handling wet, slippery materials easier & safer
- Suitable for handling drums & plant maintenance
- Wide spectrum chemical resistance

Part No. : 08-354 (14")

JKKP HP 04/01 EN420, EN388, EN374



PVA Glove

- Outperforms most other chemicals resistance gloves in aromatic & chlorinated solvents

Part No. : 15-554 (14")

JKKP HP 12/01 EN420, EN388, EN374



Green PVC Apron

Heavy-duty 20mil, 35" x 45".

Applications

Food handling and preparation, industrial maintenance & chemical processing

Product Code: 56-100



Goldknit Kevlar Sleeve

- 100% kevlar with thumb slot & velcro strap
- Protect forearms from heat & burn as well as cuts
- Safeknit spectra sleeve
- Lightweight spectra

Part No. : 70-138 (18")

Hyflex Kevlar Sleeve

Superior mechanical protection and cut-resistance

- Automatic knit liner
- Exceptional cut resistance up to 100°C
- Thumbslot for additional protection of the wrist

Part No. : 70-114 (14")



Sleeve Style 50#

Safety Sleeves for High mechanical & heat protection

Composition

- 100% TAEKI5® fiber
- With or without thumb hole
- Length available : 10", 14", 16", 18", 24"
- Custom color available : Dark to high visibility color

Properties

- Heat contact protection
- High cut resistance
- UV resistance. Keep properties and color in contact with light
- Lint free
- Washable

Typical Handling

- Automotive
- Glass
- Steel
- Welding
- Clean room or clean environment application



Protective Gloves



B0600 Top Fit **MAXIMUM DEXTERITY**

Coating is restricted to the fingertips, the part of the hand most exposed to micro-cuts.



B0500 Palm Fit White **HIGH DEXTERITY**

Seamless nylon line.
Polyurethane-coated palm.

A glove with a ventilated back, which protects the palm and fingers while completely freeing the hand's movements.



370 Assembly Grip Black

ANTISKID, DEXTERITY
Seamless nylon liner.
Nitrile-coated palm.

Black coloring is ideal for work in dirty environments.



377 Nitrile Foam Grip

FULL NITRILE COATING
DOUBLED WITH FOAM NITRILE COATING ON PALM LONGER REINFORCED KNIT CUFF

Oil resistant. Optimal protection.

Full protection and optimal grip in dry, oily, greasy or even oil submersion environments. Impermeable until the knitwrist



380 NBR Foam Grip **ANTISKID, DELICATE WORK**

Seamless, sticky nylon liner.
Nitrile foam-coated palm.

The dotted microporous nitrile foam provides a strong grip on slippery parts or surfaces that require highly secure movements and optimal dexterity. Whilst the lightweight nylon liner is well ventilated and fits to the contours of the hand.



381 Breathable Microfiber Glove

MAXIMUM DEXTERITY

Provides the lightest SHOWA microporous nitrile coated glove with an abrasion resistance up to level 4. It's design and comfort is further enhanced as breathability and moisture evacuation by 20% more than our standard offering.



541 Palm Plus **HIGH DEXTERITY-PROTECTION**

Seamless HPPE liner
Polyurethane-coated palm.

Level 3 cut resistance. A glove that is supple and light, with a ventilated back and a grey colouring that does not show the dirt. Provides a high degree of comfort when performing delicate tasks in work environments that are greasy and where the risk of cuts is high.



600 PVC Green **HIGH DEXTERITY AND COMFORT**

PVC-dipped, seamless cotton liner.

This ultra-supple closed glove, with its thick cotton liner and rough surface, ensures a secure grip on tools and other objects, and allows remarkable freedom of movement while providing effective protection against most phytosanitary products.



160 Oil Resistant Unlined

SECOND SKIN, REUSABLE Dipped PVC (Unlimited and without flocking).

Glove with an extremely soft and thin sleeve (0.3 mm thick). Anallergic and antibacterial. Reinforced chemical protection (hydrocarbon treated). Patterned finish for a secure grip. Easy to put on and remove (Slip-on treatment). Optimal tactility and dexterity.



660 Oil Resistant MAX PROTECTION, DEXTERITY

Fine, Seamless, PVC-dipped cotton liner.

Ultra-supple, waterproof long sleeve glove with a rough surface. Wide-spectrum chemical protection. Comfortable and soft, allows objects to be gripped firmly. Length 30 cm.



660 ESD Oil Resistant ANTISTATIC

Version that protects the objects or products handled from static electricity, thanks to its special coating and nylon liner (surface resistivity of 108 to 109 @).



720 Nitrile DEXTERITY

Fine seamless, nitrile-dipped polyester/nylon liner.

A fine, supple glove (1.1 mm thick) with a seamless liner and a rough surface, offering high chemical resistance and excellent protection against abrasion. For demanding tasks that require manual exertion and complete control over tools or work materials.



B0700 Clean White Unsupported Pvc coating.

Seals and protects the hand against chemicals while remaining flexible. Impermeable for working in damp or greasy environments. Surface enables a secure grip on slippery objects.



690 Oil Resistant Long Sleeve

Heat-bonded long-sleeve version (60cm) with an elasticated border, equipped with a ventilation eyelet.



SHW 772 ARX Nitrile Long Sleeve

Heat-bonded long-sleeve version (65cm) with an elasticated border, equipped with a ventilation eyelet.



Protective Gloves



GP-KV2R Nitrile Kevlar® Grip

ANTISKID

Seamless Kevlar® liner. Nitrile-coated palm.

Level 4 cut resistance. Non-reinforced Kevlar version with a roughly finished nitrile coating. For more abrasive activities or those performed in a greasy environment.



317 Hi-Viz

Polyester knit natural latex coating.

A flexible, robust glove offering great dexterity and with good resistance to tearing. Protects the hand in damp environments or against aggressive detergents or alcohols.



310 Grip Green

HEAVY WORK > GRIP

Seamless cotton/polyester line. Latex-coated palm.

Resistant to abrasion, protects from micro-cuts and ensures excellent grip. Ventilated back of the hand. Ideal when working for extended periods, as it prevents hand fatigue.



350R Nitrile Grip

ANTISKID, HEAVY WORK

A hardwearing glove with a ventilated back.

Ideal when a strong grip is needed and for the transport of heavy, bulky, slippery objects. The thick but supple liner protects the hand from friction without reducing mobility.



GP-KV1 Kevlar® Grip

GRIP

Seamless Kevlar® liner. Latex-coated palm.

Level 4 cut resistance. Non-reinforced Kevlar® version. The roughly finished latex on the palm allows objects and tools to be gripped firmly.



S-TEX KV3

LEVEL 5++ PROTECTION

Kevlar® liner reinforced with stainless steel. Latex-coated palm.

This latex-coated glove features a reinforced Kevlar® liner softened using polyester, as well as a ventilated back. It far exceeds the maximum level of cut resistance specified by the EN 388 standard, while remaining very light and flexible. For all glasswork, metalwork or building and public works applications that require work gloves to be worn continuously.



S-TEX#521 Kevlar® Grip

Cut Resistant Inner Glove

Level. High cut resistant Performance with Dexterity & Durability

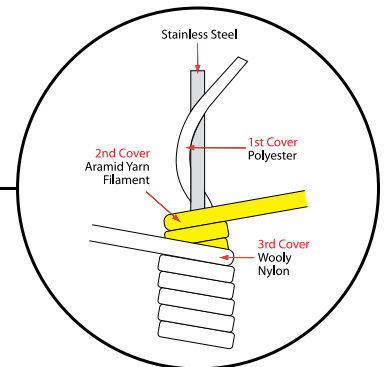

Hagane Coil Technology

"HAGANE COIL" a stainless steel composite yarn developed by Showa Glove Co. for cut resistant. Covering by various yarns it provides various strength (e.g. cut resistant & flexibility)



NJ506

15G nylon/spandex liner with micro foam nitrile coating

- Seamless liner and ergonomic design assure a maximum comfort and minimum hand fatigue.
- Micro foam nitrile coatings are compatible with light oils and will provide a good grip and excellent abrasion resistance.
- Black coating surface hides dirt and grime.
- Micro foam nitrile coating offers absolute breathability.
- Knit wrist helps prevent dirt and debris from entering the glove.



NKX352

13G HPPE/glass fiber liner double dipped sandy nitrile coating

- Full nitrile sandy double coating provides a superior grip in dry, wet and oily conditions.
- Seamless knit HPPE and glass fiber shell offers increased comfort, finger dexterity and breathability, high assurance and labor protection.
- The liner color can be customized.
- Knit wrist helps prevent dirt and debris from entering the glove.
- Excellent resistance to liquid permeation.
- Oil does not penetrate the glove like foam nitrile styles.



NG423A

Cotton jersey liner safety cuff with 3/4 nitrile coating

- Jersey knit liner with safety cuff.
- Heavy nitrile coating offers great grip performance.
- 3/4 nitrile coating brings extended protection.
- The coating can be customized.
- Excellent puncture and tear resistance.



WE7123

7 gauge Kevlar® shell

- 100% genuine Kevlar® 7 gauge seamless knitted liner increase comfort.
- Kevlar® give cut resistance together with heat resistance.
- While maintaining flexibility, soft and dexterity.
- Extra yam on thumb crotch provide more protection.
- Provide excellent heat resistance, can afford contact heat 100 degree.



W744-38

7 gauge Kevlar® terry heat resistance glove

- 100% genuine Kevlar® 7 gauge seamless knitted liner increase comfort.
- Kevlar® give cut resistance together with heat resistance.
- While maintaining flexibility, soft and dexterity.
- Extra yam on thumb crotch provide more protection.
- Provide excellent heat resistance, can afford contact heat 100 degree.
- Ambidextrous and washable.



HTR-0077

Knitted with anti-cut yarn, with anti-cut & anti-tear performances, preventing hands from being cut by sharp metal, glasses, etc.



HTR-0061

Knitted with anti-cut yarn by imported knitting machine; leather palm to provide better abrasion and puncture resistance.



First Aid Kit



O.S.H.A FIRST AID KIT

Occupational Safety And Health Act

Since 1967 Factories And Machinery Forth Schedule Regulation 38 (2) (I) First Aid Kit



Box A

Workplace with 1-10 persons employer



Recommended PM-OSHA-A Window Outer PMW-OSHA-A Weather Proof PMWP-OSHA-A

PM-OSHA-A, PMW-OSHA-A
Size: 300(L) x 100(W) x 250(H)mm Weight: 2.4kg

PMWP-OSHA-A
Size: 325(L) x 115(W) x 285(H)mm Weight: 5.5kg

Box B

Workplace with 11-50 persons employer



Recommended PM-OSHA-B Window Outer PMW-OSHA-B Weather Proof PMWP-OSHA-B

PM-OSHA-B, PMW-OSHA-B
Size: 300(L) x 120(W) x 280(H)mm Weight: 3.4kg

PMWP-OSHA-B
Size: 410(L) x 135(W) x 325(H)mm Weight: 7.6kg

Box C

Workplace with over 50 persons employer



Recommended PM-OSHA-C Window Outer PMW-OSHA-C Weather Proof PMWP-OSHA-C

PM-OSHA-C, PMW-OSHA-C
Size: 470(L) x 130(W) x 340(H)mm Weight: 5.1kg

PMWP-OSHA-C
Size: 510(L) x 145(W) x 390(H)mm Weight: 11.0kg

PVC Casing of - First Aid Kit



Double Fold Stretcher with sewn 2 straps & carry bag



Frame made of high-strength aluminium alloy with Durable Water Proof PVC Coated Nylon Canvas 1000D Orange color with sewn 2 strap and carrying bag. It is light-weighted, compact and totally portable.

Unfolded Size 221(L) x 53(W) x 15(H)cm **Load Bearing** 159kg
Folded Size 110(L) x 18(W) x 11(H)cm **Self Weight** 5.8kg

AED Cabinet



- Included with Siren Sound and Light.
- Allow to mounted on wall. Break glass to get the key.
- Include with 9v battery and 2 keys.

Cabinet Size 330(L) x 160(W) x 300(H)cm **Weight** 3.9kg



FULL BODY HARNESS



BS-106

Specification:

- Polyester webbing in 45mm width
- Rear Dorsal D-ring attachment point
- 5 Adjustable points
- 2 Sliding plates for easy adjust
- 2 Reflective tape in front
- Webbing strength > 22kN
- Max loading in 100 kgs
- Free size
- CE EN361:2002
- Origin: CN

LANYARDS



BS-206

- Twisted rope lanyard
- 1.8m length; 14mm diameter
- 1 alloy steel carabiner
- 1 big forged snap hook w/50mm opening
- Static strength > 22kN; CE EN354:2010



BS-203

- Energy absorber twisted rope lanyard
- 1.8m length; 14mm diameter
- 1 (or 2) alloy steel carabiner
- 1 big forged snap hook w/50mm opening
- Static strength > 22kN
- CE EN354:2002, EN354:2010



Twin Energy Absorbing Lanyard

BS-206 + BS-203

- Flexible set of 2 independent twisted rope lanyard
- 1.8m length; 14mm diameter
- Energy absorber w/2 alloy steel steel carabiner and 2 big forged snap hook w/50mm opening



SAFETY PADLOCKS



Zenex™ 406

Composite body / Key retaining / Composite Nylon shackle / Non-conductive padlock / Dielectric protection Non-sparking / Corrosion & chemical resistant Pull strength resistance in closed position: 114kg Withstands temperatures ranging from -57 °C to +177 °C Safe to use in hazardous area & explosive atmospheres



Zenex™ 410

Composite body / Key retaining / Hardened steel shackle Corrosion & chemical resistant Withstands temperatures ranging from -57 °C to +177 °C



Zenex™ 411

Composite body / Key retaining / Hardened steel shackle Corrosion & chemical resistant Withstands temperatures ranging from -57 °C to +177 °C

Laminated Steel Padlock

Chrome plated & boron alloy steel shackles. Excellent corrosion resistance. Supplied with 2 keys (can be supplied with 1 key). Options available: Keyed-different (KD) / Keyed alike (KA) / Master Keyed (MK)



Laminated Steel Padlock 3

Steel shackle. Supplied with 2 keys (can be supplied with 1 key). Option available: Keyed-different (KD) / Keyed alike (KA) / Master keyed (MK)



LOCKOUT STATION

Lockout Station Holds Locks, Hasps and Devices

- Durable construction for years of use in corrosive environments
- Top and bottom compartments each have 5 moveable dividers for organizing devices
- 8 Hanger clips hold 2 padlocks or lockout hasps each
- Holes provided inside and along bottom for optional peghook hanger clips. Allows you to organize further. Large devices can be hung below
- Cover protects padlocks and devices from dust and grime
- Lockable. Use combination padlock to limit access to authorized employees
- Measures 15-1/2" high x 22" wide x 4-1/8" deep
- Available with Electrical or Value Lockout Focus. Includes most commonly required lockout devices
- Available filled or unfilled



S1850V3



1483BP3ES

SAFETY LOCKOUT / TAGOUT



417 Lock-out Hasps

Aluminium body / Vinyl Coated. Spark resistant / Hold up to six padlocks with shackle up to 6.35mm dia.



421 Lock-out Hasps

Steel Lock-out Hasp / Red Vinyl Coated Handle. Hold up to six padlocks with shackle up to 6.35mm dia.



Tag 1



Tag 2



Tag 3



Back



TRAFFIC CONES



Road Cones - RCH30 (Square Base)

Material	Polyethylene
Colour	Luminescent orange
Base Dimensions (mm)	Hexagonal/ Square
Weight Type	Sand
Special Features	High visibility Good stability Long-term placement



Flexi Post - 30"

Material	Dow Elite (Toy Material)
Colour	Luminescent orange
Base Dimensions (mm)	200mm (B) X 750mm (H)
Weight Type	Ground intact
Special Features	High visibility Good stability Long-term placement

STAINLESS STEEL CONVEX MIRROR (OUTDOOR USE)



SSCM 320



SSCM 490



SSCM 600



SSCM 800

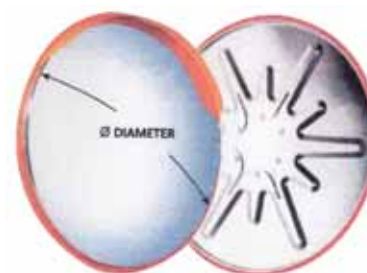

SSCM 1000

Round Shape

Code	SSCM 320	SSCM 490	SSCM 600	SSCM 800	SSCM 1000
Diameter (mm)	Ø320	Ø490	Ø600	Ø800	Ø1000
Carton Size (mm)	365 x 365 x 70	565 x 565 x 63	680 x 680 x 175	905 x 895 x 128	1105 x 1095 x 128
Qty Carton	1				
Setup Method	Wall / Pole mounted			Pole mounted	

SAFETY VEST



L Shape Netting Vest



Safety Netting Vest



Elastic Vest



Polyester Safety Vest



Safety Signages



S013 600x1800mm * Wall mount @ with post



S031 600x1800mm * Wall mount @ with post



S014 600x400mm



S037 400x300mm / 600x400mm



P084 400x300mm / 600x400mm



S026 400x300mm / 600x400mm



S007 600x400mm / 400x300mm



S008 600x400mm / 400x300mm



MX004 400x600mm / 600x900mm

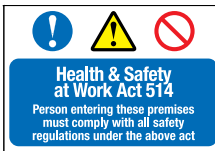

MX005 400x600mm / 600x900mm



MX013 400x600mm / 600x900mm



MX015 400x600mm / 600x900mm



E001 150x300mm



E002 150x300mm



E025 170x600mm

1D (ONE Dimension) Signs

(Material Available: 1mm PVC & THK 2.0mm Acrylic)



F001 200x200mm



F002 200x200mm



F003 200x200mm

2D (TWO Dimension) Signs

(Material Available: THK 2.0mm Acrylic)



F016 200x230mm



F017 200x230mm



F018 200x230mm

3D (Three Dimension) Signs

(Material Available: THK 2.0mm Acrylic)

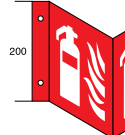

F009 200x460mm

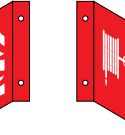

F010 200x460mm

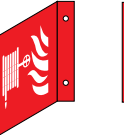

F011 200x460mm

Fire Extinguisher MISSING Signs



F034 800x300mm



F035 800x300mm



M001 400x300mm / 600x400mm



M002 400x300mm / 600x400mm



M003 400x300mm / 600x400mm



M005 400x300mm / 600x400mm



W001 400x300mm / 600x400mm



W008 400x300mm / 600x400mm



W009 400x300mm / 600x400mm



P001 400x300mm / 600x400mm



P005 400x300mm / 600x400mm



P009 400x300mm / 600x400mm



M006 400x300mm / 600x400mm



M007 400x300mm / 600x400mm



M008 400x300mm / 600x400mm



M010 400x300mm / 600x400mm



W010 400x300mm / 600x400mm



W011 400x300mm / 600x400mm



W012 400x300mm / 600x400mm



P010 400x300mm / 600x400mm



P011 400x300mm / 600x400mm



P015 400x300mm / 600x400mm



M011 400x300mm / 600x400mm



M012 400x300mm / 600x400mm



M017 400x300mm / 600x400mm



M019 400x300mm / 600x400mm

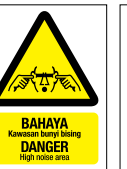

W013 400x300mm / 600x400mm



W014 400x300mm / 600x400mm



W024 400x300mm / 600x400mm



S001 400x300mm / 600x400mm



S002 400x300mm / 600x400mm



S003 400x300mm / 600x400mm

P.S.P. Marketing Sdn. Bhd. (288933-W)

HEAD OFFICE:

No.3, Jalan Meru Indah 22/KU8, Kaw. Perindustrian Meru Barat,
42200 Kapar, Selangor D.E. Malaysia
Tel: 603-3393 8099 (hunting) / 2099 / 2199 / 2599 Fax: 603-3393 0199

PENANG BRANCH OFFICE:

No. 8, Jalan Kelisa Emas 2, Taman Kelisa Emas,
13700 Seberang Jaya, Penang, Malaysia.
Tel: 604-398 4006 / 5006 / 7006 Fax: 604-398 7032

JOHOR BRANCH OFFICE:

No. 22, Jalan Mutiara Emas 5/21, Taman Mount Austin,
81100 Johor Bahru, Johor, Malaysia.
Tel: 607-351 1028 / 0796 Fax : 607-351 1127

E-mail: pspmktg@psp.com.my | www.psp.com.my